

ConteralP® Outdoor Dome EX Megapixel Camera

5 Megapixel (MP) H.265/H.264 All-in-One Motorized P-Iris Lens True Day/Night Indoor/Outdoor Dome IP Camera with SNAPstream+™ (Smart Noise Adaptation and Processing), Enhanced WDR™ (Wide Dynamic Range), NightView™, Smart IR, and Video Analytics

H.265



The ConteralP® Outdoor Dome EX megapixel camera features 5-megapixel (MP) resolution for optimum performance. The ConteralP Outdoor Dome combines a day/night mechanical IR cut filter with an integrated motorized remote focus and zoom precision iris (P-iris) lens for excellent, optimal image quality. The ConteralP Outdoor Dome EX is ONVIF (Open Network Video Interface Forum) Profile S, G, and T compliant, providing interoperability between network video products regardless of manufacturer.















The inclusion of on camera video analytics gives the ConteralP Outdoor Dome EX the ability to increase situational awareness and gather data for business intelligence. Alarm conditions can be setup to alert security for observed behaviors. Several of the analytic behaviors can also be used for business intelligence data gathering, such as the loitering behavior for tracking dwell time in retail environments.

Regardless of the time of day, the ConteralP Outdoor Dome EX is prepared for any lighting condition. Enhanced WDR™ (wide dynamic range) at 120dB provides the best visual balance to shaded and bright

light conditions, NightView™ offers strong low-light sensitivity for capturing details in extremely poor-lit scenes, and built-in Smart IR LED illumination automatically adjusts output in response to the distance of an object in view to prevent over-exposure when the object is very close to the camera.

AV Costar™ was the first to bring H.264 to the mainstream market and recently developed SNAPstream™ (Smart Noise Adaptation and Processing) technology for reducing bandwidth without impacting image quality. Today we are proud to offer our next generation H.265 with SNAPstream+™ smart codec capable of delivering high quality video while saving over 50% of the data rate to reduce or prevent strain on the network.

The microSD card slot supports up to 256GB of storage capacity for convenient onboard storage. The camera's power can be supplied via a Power-over-Ethernet (PoE - IEEE 802.3af) compliant network cable connection. The ConteralP Outdoor Dome EX is IP66 rated for both indoor and outdoor applications. All models feature an impact resistant cast-aluminum housing capable of withstanding the equivalent of 55 kg (120 lbs) of force.

 Integrated Motorized Lens with Remote Focus and Zoom	 P-Iris Control for Best Depth of Field and Image Clarity	 Smart IR LEDs	 True Day/Night with IR Cut Filter	 All-in-One PoE and Integrated Lens	 Impact / Weather Resistant IK-10 and IP66 Rated	 Advanced Video Analytics
 SNAPstream+™ Technology	 NightView™	 Enhanced WDR™ Wide Dynamic Range	 CorridorView™ with 90° Image Flip	 Tri-Encoder H.265/H.264/MJPEG	 SDXC Card Slot	 Installer Friendly

Series Features

- 5MP Resolution
- Advanced Video Analytics
- Remote Focus/Zoom Motorized P-Iris Lens
- SNAPstream+™ Capability to Reduce Bandwidth without Impacting Image Quality
- NightView™ for Strong Low Light Performance
- True Day/Night Functionality with Mechanical IR Cut Filter
- Enhanced WDR up to 120dB at Full Resolution: See Clearly in Shaded and Bright Light Conditions Simultaneously
- CorridorView™ Allows 90° Image Rotation for Better Coverage in Hallways and Corridors
- Privacy Mask, Motion Detection, Bit Rate Control, Multi-Streaming, Multicasting, Forensic Zooming, and Scaling
- On-Screen Display (OSD)
- Defog Technology
- Triple Encoder: H.265/H.264/MJPEG
- Network Protocols Include SNMP, HTTPS, IPv6, DHCP, 802.1x, and More
- All-in-One H.265/H.264 Total PoE Solution (No External Power Required for Heater and IR LEDs), PoE and Auxiliary Power: 12–48V DC/24V AC
- Smart IR Illumination with Variable Illumination Ensures that IR Light is Evenly Disbursed up to 66ft (20m) for Scenes with Low or No Ambient Light
- Audio In / Out (Accessory Sold Separately)
- MicroSDXC Card Slot for Onboard Storage
- Outdoor Rated IP66 and IK-10 Impact-Resistant Housing
- Easily Adjustable 3-Axis Gimbal

Camera Imaging Specifications

Model	AV5456PMIR-S	
Image Sensor	5MP CMOS Progressive Sensor	
Optical Format	1/2.9"	
Minimum Illumination	Color (Day Mode)	0.1 Lux
	B/W (Night Mode)	0.01 Lux
Full FOV Resolution	2592 H x 1944 V	
Scaling (See <i>Scaling Resolutions Below</i>)	Yes	
IR Illumination	Yes	
Dynamic Range	120dB	
Frame Rates ¹	Single Stream	Up to 30fps (5MP) ²
	Multi-Stream	Up to 15fps (5MP) ² + 10fps (5MP) ²
		Up to 30fps (1080p) ² + 30fps (720p) ² + 30fps (VGA) ²
Lens	Motorized Lens	2.7–12mm, F1.3, H-FOV = 24°–81°, V-FOV = 18°–57°, P-Iris

Programmability

Optics	Remote focus, remote zoom
Low-Light Performance	NightView™ technology
	Smart IR
Programmable Shutter Speed	Auto/manual 0.1ms ~ 500ms
Motion Detection	Real-time, 1024 detection zones
Privacy Masking	Unlimited
Backlight Compensation	Auto
White Balance Mode	Auto/manual
Gain Control	Auto
Flicker Control ²	5Hz–255Hz selectable
Image Rotation	CorridorView™ (90°, 180°, and 270° image rotation) + mirror
Scaling	2592x1944, 2048x1536, 1920x1080, 1296x972, 1280x720, 640x480, 640x360, 320x240
Wide Dynamic Range	Adjustment between WDR and LDR modes
Efficiency	SNAPstream+™ (Smart Noise Adaptation and Processing)
	Bit rate and bandwidth limitation control
Defog	Supported
Miscellaneous	Programmable brightness, contrast, sharpness, saturation, hue
	Electronic pan, tilt, zoom (PTZ)
Password	16-digit ASCII character password
On-Screen Display (OSD)	Time/date/camera name/custom text
Basic Video Analytics	Motion Detection
	Camera Tamper
Advanced Video Analytics ⁴	Intrusion Detection
	Line Crossing
	Loitering
Optional Advanced Video Analytics ⁵	Object Classification (Person/Vehicle) ⁵
	Object Left/Removed ⁵
	People/Vehicle Counting ⁵

- 30 frames per second (FPS) maximum with H.264 and H.265 compression at 60 hertz (Hz), up to 25fps maximum at 50Hz
- Max FPS with Enhanced WDR™ turned on will be up to 50% of listed FPS
- Limited to 180° rotation with video analytics enabled
- Analytics are not designed for heavy traffic locations such as roads and intersections
- Requires Optional Advanced Video Analytic License

Data Transmission

Compression Type	H.265/H.264 (MPEG-4, Part 10)/Motion JPEG
Bit Rate Control	64K–8000K
Smart Codec	Smart GOP/Smart ROI
Transmission Protocols	SNMP, HTTP, HTTPS, IPv6, IPv4, SSL, TCP/IP, UPnP, UDP, RTCP, RTSP, RTP, SMTP, NTP, DHCP, FTP, 802.1x, Zero Configure
	10/100Base-T Ethernet network interface, RJ45
Multi-Streaming	2 x H.265/H.264 stream, 1 x M-JPEG stream
Users	Live viewing/Administrator for up to 10 clients

Event Management

Event Trigger	Motion detection, video analytics, alarm in
Notifications	Send/record message via e-mail/FTP/NAS/SD card, record JPG/mp4

Compliance

Industry Standard	ONVIF Profile S, G, T conformant
Listings	UL (CB) UL60950-1, E489591
FCC Compliance	47 CFR 15 Class A
Environmental	RoHS, REACH, WEEE
Markings	CE: EN55032 Class A, EN55024, EN61000-3-2, EN61000-3-3, EN60950
Mechanical	IK-10 (EN62262), IP66 (EN60529)

Environmental

Operating Temperature	-20°C (-4°F) to +50°C (122°F)
Humidity	0% to 90% (non-condensing)
Storage Temperature	-40°C (-40°F) to +60°C (140°F)

General Electrical

Alarm Input/Output	1 input (wet contact)/1 output (wet contact)	
Power Over Ethernet	PoE IEEE 802.3af, Class 3	
	Total PoE solution (no external power requirement)	
Auxiliary Power	12–48V DC, 24V AC	
Power Consumption	1080p	5.5W PoE max
	5MP	6.5W PoE max

IR Illuminator

LEDs	12pcs, Smart IR
Projection Distance	66ft (20m) max

Audio Electrical

Streaming	Two-way
Compression	G.711 PCM 8 kHz
Input/Output	Line in® / Line output

Mechanical

Casing	Die-cast aluminum chassis with 4" polycarbonate dome bubble	
	IP66 weather proof standard	
	Impact resistant, IK-10 rated	
Gimbal	Easily adjustable 3-axis camera gimbal w/360° pan, 77° tilt and 180° z-axis	
Dimensions <i>(See Dimensions)</i>	Unit	Ø 5.77" (146.7mm) x 5.42" H (137.6mm)
	Packaged	6" H (150mm) x 7.5" W (190mm) x 8" L (200mm)
Weight	Unit	2.65lbs (1.2kg)
	Packaged	3.31lbs (1.5kg)
On Board Storage	MicroSDXC slot up to 256GB (card not included)	
Body Color	AV Costar White (Pantone® Cool Gray 1C)	

Dimensions

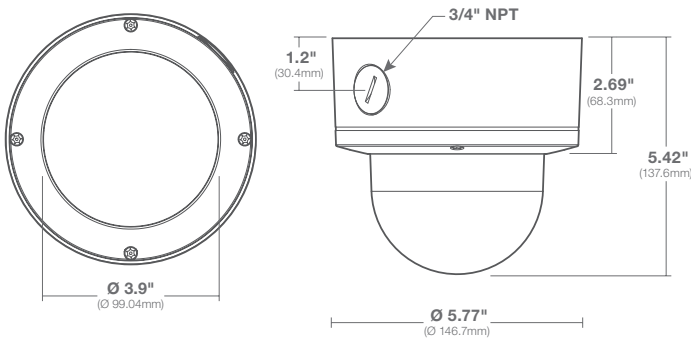

6. Requires Amplification

See Next Page for Ordering Information



Model Numbers

5MP	AV5456PMIR-S	WDR
------------	--------------	------------

Optional Advanced Video Analytic License

AV-CADVA1	Enables Optional Advanced Video Analytic Behaviors on ConteraIP EX Cameras
------------------	--

Accessories

AV-1AK	ConteraIP Outdoor Dome Optional Audio Kit
AV-CRMA-W	Corner Mount Adapter (AV Costar White)
AV-FMA	Flush Mount Adapter (White)
AV-PMA-W	Pole Mount Adapter (AV Costar White)
AV-PMJB-W	Pendant Mount Bracket with Standard Junction Box (AV Costar White) <i>(Fits Cap 1.5" NPT, Box Fits 3/4" NPT)</i>
AV-WMJB-W	Wall Mount Bracket with Standard Junction Box (AV Costar White) <i>(Fits Cap 1.5" NPT, Box Fits 3/4" NPT)</i>
MD-CAP-W	Mounting Cap for ConteraIP Outdoor Dome (AV Costar White)
MD-JBA-W	Round Junction Box for ConteraIP Outdoor Dome (AV Costar White) <i>(Fits 3/4" NPT)</i>

Configurations



Surface mount dome

Create Your Model (Example: AV5456PMIR-S)

Megapixel Resolution	Generation	Body Type	Compression	Lens	Infrared	Onboard Storage
----------------------	------------	-----------	-------------	------	----------	-----------------



+1.818.937.0700 | www.avcostar.com | avsales@arecontvision.com

© 2020 Arecont Vision Costar, LLC. All rights reserved. Arecont Vision, Contera, and ConteraIP are registered trademarks of the company. AV Costar, the AV Costar logo, CorridorView, Enhanced WDR, NightView, SNAPstream, and SNAPstream+ are business use trademarks of the company.

Rev 001.004

